

SERVICE AND PARTS MANUAL FOR BLOWER MODEL

DR404 – DR656



AMETEK Dynamic Fluid Solutions
100 East Erie St., Kent, Ohio 44240
Telephone: 330-673-3452 Fax: 330-677-3306
email: dfs.information@ametek.com
internet: www.ametekdfs.com

Your Choice. Our Commitment.™

WARRANTY, INSTALLATION, MAINTENANCE AND TROUBLESHOOTING INSTRUCTIONS



AMETEK Dynamic Fluid Solutions
100 East Erie St., Kent, Ohio 44240
Telephone: 330-673-3452 Fax: 330-677-3306
email: dfs.information@ametek.com
internet: www.ametekdfs.com

1. AMETEK Rotron DR, EN and HiE regenerative direct drive blowers are guaranteed for one full year from the date of installation (limited to 18 months from the date of shipment) to the original purchaser only. Should the blower fail we will evaluate the failure. If failure is determined to be workmanship or material defect related, we will at our option repair or replace the blower.
2. AMETEK Rotron Minispiral, Revaflow, Multiflow, Nautilair, remote drive blowers, moisture separators, packaged units, CP blowers, Nasty Gas™ models and special built (EO) products are guaranteed for one full year from date of shipment for workmanship and material defect to the original purchaser only. Should the blower fail, If failure is determined to be workmanship or material defect related, we will at our option repair or replace the blower.
3. **Parts Policy** - AMETEK Rotron spare parts and accessories are guaranteed for three months from date of shipment for workmanship and material defect to the original purchaser only. If failure is determined to be workmanship or material defect related we will at our option repair or replace the part.

Corrective Action - A written report will be provided indicating reason(s) for failure, with suggestions for corrective action. Subsequent customer failures due to abuse, misuse, misapplication or repeat offense will not be covered. AMETEK Rotron will then notify you of your options. Any failed unit that is tampered with by attempting repair or diagnosis will void the warranty, unless authorized by the factory.

Terms and Conditions - Our warranty covers repairs or replacement of regenerative blowers only, and will not cover labor for installation, outbound and inbound shipping costs, accessories or other items not considered integral blower parts. Charges may be incurred on products returned for reasons other than failures covered by their appropriate warranty. Out-of-warranty product and in warranty product returned for failures determined to be caused by abuse, misuse, or repeat offense will be subject to an evaluation charge. Maximum liability will in no case exceed the value of the product purchased. Damage resulting from mishandling during shipment is not covered by this warranty. It is the responsibility of the purchaser to file claims with the carrier. Other terms and conditions of sale are stated on the back of the order acknowledgement.

Installation Instructions for SL, DR, EN, CP, and HiE Series Blowers

1. **Bolt It Down** - Any blower must be secured against movement prior to starting or testing to prevent injury or damage. The blower does not vibrate much more than a standard electric motor.
2. **Filtration** - All blowers should be filtered prior to starting. Care must be taken so that no foreign material enters the blower. If foreign material does enter the blower, it could cause internal damage or may exit at extremely high velocity.

Should excessive amounts of material pass through the blower, it is suggested that the cover(s) and impeller(s) be removed periodically and cleaned to avoid impeller imbalance. Impeller

imbalance greatly speeds bearing wear, thus reducing blower life. Disassembling the blower will void warranty, so contact the factory for cleaning authorization.

- Support the Piping** - The blower flanges and nozzles are designed as connection points only and are not designed to be support members.

Caution: Plastic piping should not be used on blowers larger than 1 HP that are operating near their maximum pressure or suction point. Blower housing and nearby piping temperatures can exceed 200°F. Access by personnel to the blower or nearby piping should be limited, guarded, or marked, to prevent danger of burns.

- Wiring** - Blowers must be wired and protected/fused in accordance with local and national electrical codes. All blowers must be grounded to prevent electrical shock. Slo-Blo or time delay fuses should be used to bypass the first second of start-up amperage.
- Pressure/Suction Maximums** - The maximum pressure and/or suction listed on the model label should not be exceeded. This can be monitored by means of a pressure or suction gage (available from Rotron), installed in the piping at the blower outlet or inlet. Also, if problems do arise, the Rotron Field representative will need to know the operating pressure/suction to properly diagnose the problem.
- Excess Air** - Bleed excess air off. DO NOT throttle to reduce flow. When bleeding off excess air, the blower draws less power and runs cooler.

Note: Remote Drive (Motorless) Blowers - Properly designed and installed guards should be used on all belts, pulleys, couplings, etc. Observe maximum remote drive speed allowable. Due to the range of uses, drive guards are the responsibility of the customer or user. Belts should be tensioned using belt gauge.

Maintenance Procedure

When properly piped, filtered, and applied, little or no routine maintenance is required. Keep the filter clean. Also, all standard models in the DR, EN, CP, and HiE series have sealed bearings that require no maintenance. Bearing should be changed after 15,000 to 20,000 hours, on average. Replacement bearing information is specified on the chart below.

Bearing Part Number	Size	Seal Material	Grease	Heat Stabilized
510217 510218 510219	205 206 207	Polyacrylic	Nye Rheotemp 500 30% +/- 5% Fill	Yes – 325 F
510449 516440 516648	203 202 307	Buna N	Exxon Polyrex Grease	NO
516840 516841 516842 516843 516844 516845 516846 516847	206 207 208 210 309 310 311 313	Buna N	Exxon Polyrex Grease	NO

Troubleshooting

		POSSIBLE CAUSE	OUT OF WARRANTY REMEDY ***
IMPELLER DOES NOT TURN	Humming Sound	<ol style="list-style-type: none"> * One phase of power line not connected * One phase of stator winding open Bearings defective Impeller jammed by foreign material Impeller jammed against housing or cover ** Capacitor open 	<ol style="list-style-type: none"> Connect Rewind or buy new motor Change bearings Clean and add filter Adjust Change capacitor
	No Sound	<ol style="list-style-type: none"> * Two phases of power line not connected * Two phases of stator winding open 	<ol style="list-style-type: none"> Connect Rewind or buy new motor
IMPELLER TURNS	Blown Fuse	<ol style="list-style-type: none"> Insufficient fuse capacity Short circuit 	<ol style="list-style-type: none"> Use time delay fuse of proper rating Repair
	Motor Overheated Or Protector Trips	<ol style="list-style-type: none"> High or low voltage * Operating in single phase condition Bearings defective Impeller rubbing against housing or cover Impeller or air passage clogged by foreign material Unit operating beyond performance range Capacitor shorted * One phase of stator winding short circuited 	<ol style="list-style-type: none"> Check input voltage Check connections Check bearings Adjust Clean and add filter Reduce system pressure/vacuum Change capacitor Rewind or buy new motor
	Abnormal Sound	<ol style="list-style-type: none"> Impeller rubbing against housing or cover Impeller or air passages clogged by foreign material Bearings defective 	<ol style="list-style-type: none"> Adjust Clean and add filter Change bearings
	Performance Below Standard	<ol style="list-style-type: none"> Leak in piping Piping and air passages clogged Impeller rotation reversed Leak in blower Low voltage 	<ol style="list-style-type: none"> Tighten Clean Check wiring Tighten cover, flange Check input voltage
<p>* 3 phase units ** 1 phase units *** Disassembly and repair of new blowers or motors will void the Rotron warranty. Factory should be contacted prior to any attempt to field repair an in-warranty unit.</p>			

Blower Disassembly:

WARNING: Attempting to repair or diagnose a blower may void Rotron's warranty. It may also be difficult to successfully disassemble and reassemble the unit.

- 1) Disconnect the power leads. **CAUTION:** Be sure the power is disconnected before doing any work whatsoever on the unit.
- 2) Remove or separate piping and/or mufflers and filters from the unit.
- 3) Remove the cover bolts and then the cover. **NOTE:** Some units are equipped with seals. It is mandatory that these seals be replaced once the unit has been opened.
- 4) Remove the impeller bolt and washers and then remove the impeller. **NOTE:** Never pry on the edges of the impeller. Use a puller as necessary.
- 5) Carefully note the number and location of the shims. Remove and set them aside. **NOTE:** If the disassembly was for inspection and cleaning the unit may now be reassembled by reversing the above steps. If motor servicing or replacement and/or impeller replacement is required the same shims may not be used. It will be necessary to re-shim the impeller according to the procedure explained under assembly.

- 6) Remove the housing bolts and remove the motor assembly (arbor/housing on remote drive models).
- 7) Arbor disassembly (Applicable on remote drive models only):
 - a) Slide the bearing retraining sleeve off the shaft at the blower end.
 - b) Remove the four (4) screws and the bearing retaining plate from the blower end.
 - c) Lift the shaft assembly far enough out of the arbor to allow removal of the blower end snap ring.
 - d) Remove the shaft assembly from the arbor.
 - e) If necessary, remove the shaft dust seal from the pulley end of the arbor.

Muffler Material Replacement:

- 1) Remove the manifold cover bolts and them manifold cover.
- 2) The muffler material can now be removed and replaced if necessary. On blowers with fiberglass acoustical wrap the tubular retaining screens with the fiberglass matting before sliding the muffler pads over the screens.
- 3) Reassemble by reversing the procedure.

NOTE: On DR068 models with tubular mufflers it is necessary to remove the cover and impeller accessing the muffler material from the housing cavity.

Blower Reassembly:

- 1) Place the assembled motor (assembled arbor assembly for remote drive models) against the rear of the housing and fasten with the bolts and washer.
- 2) To ensure the impeller is centered within the housing cavity re-shim the impeller according to the procedure outlined below.
- 3) If blower had a seal replace the seal with a new one.
- 4) Place the impeller onto the shaft making sure the shaft key is in place and fasten with the bolt, washer and spacer as applicable. Torque the impeller bolt per the table below. Once fastened carefully rotate the impeller to be sure it turns freely.
- 5) Replace the cover and fasten with bolts.
- 6) Reconnect the power leads to the motor per the motor nameplate.

Bolt Size	Torque Pound-Force-Foot
1/4-20	6.25 +/- 0.25
5/16-18	11.5 +/- 0.25
3/8-16	20.0 +/- 0.5
1/2-13	49.0 +/- 1
5/8 -11	90.0 +/- 2

Impeller Shimming Procedure:

WARNING: This unit may be difficult to shim. Extreme care may be exercised.

Tools Needed: Machinist's Parallel Bar
Vernier Caliper with depth measuring capability
Feeler gauges or depth gauge

Measure the Following:

- Distance from the flange face to the housing (A)
- Distance from the flange face to the motor shaft shoulder (B)
- Impeller Thickness (C)

Measurements (A) and (B) are made by laying the parallel bar across the housing flange face and measuring to the proper points. Each measurement should be made at three points, and the average of the readings should be used.

$$\text{Shim Thickness} = B - (A+C)/2$$

After the impeller installation (step #4 above) the impeller/cover clearance can be checked with feeler gauges, laying the parallel bar across the housing flange face. This clearance should nominally be $(A-C)/2$.

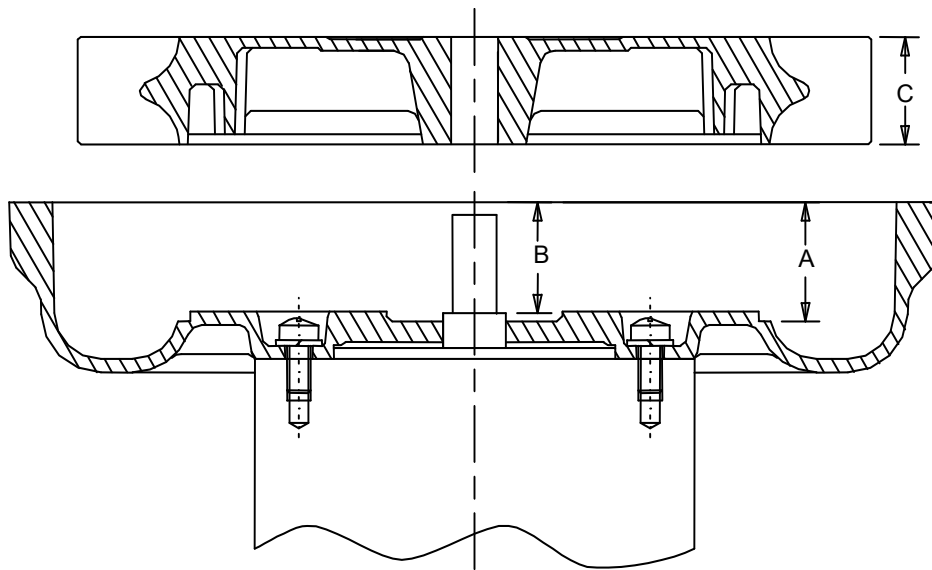

WIRING DIAGRAMS, TEFC and ODP MOTORS

A. 1Ø, 6 WIRE

115 VAC

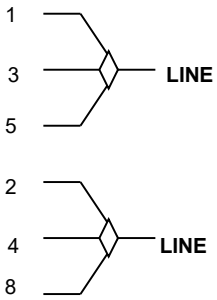

230 VAC

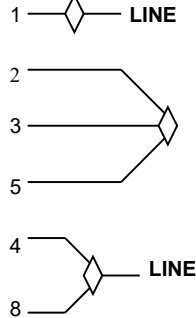

INTERCHANGE LEADWIRES 5 & 8 to REVERSE ROTATION

B. 1Ø, 7 WIRE

115 VAC

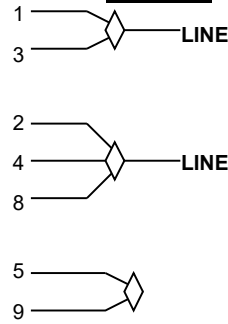

230 VAC

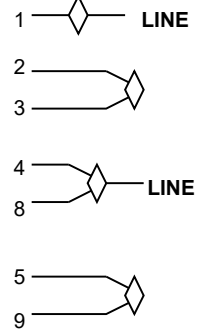

INTERCHANGE LEADWIRES 5 & 8 to REVERSE ROTATION

C. 3Ø, 9 WIRE

230 VAC

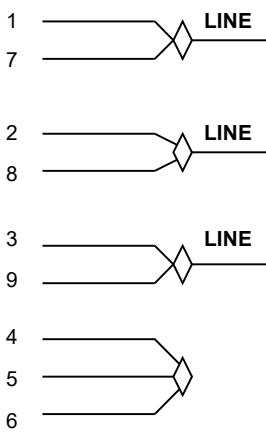

460 VAC

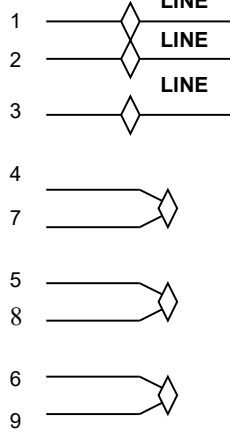

INTERCHANGE ANY TWO LEAD LINES TO REVERSE ROTATION

D. 1Ø, EMERSON 1/8 HP MOTOR

115 VAC

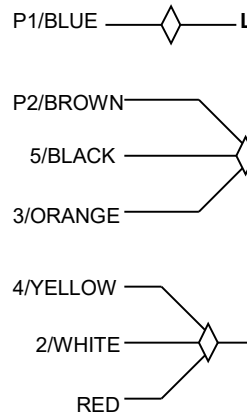

230 VAC

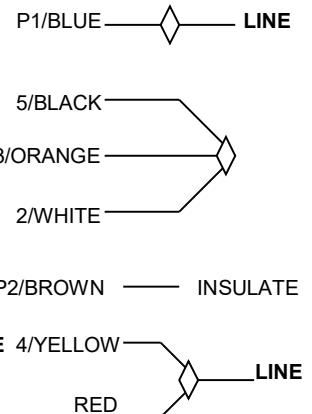

INTERCHANGE RED AND BLACK TO REVERSE ROTATION

E. 1Ø, SPA DUTY WITH TERMINAL STRIPS

LOW 115 VAC

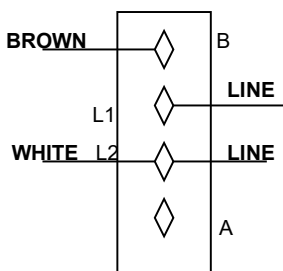

HIGH 230 VAC

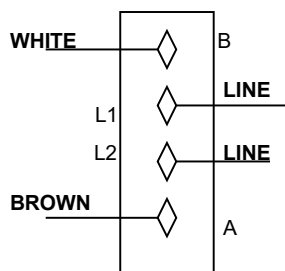

F. 1Ø, 230 VAC

SINGLE VOLTAGE

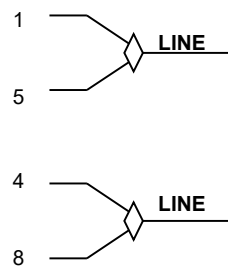

INTERCHANGE LEAD WIRES 5 & 8 TO REVERSE ROTATION

G. 3Ø, 575 VAC

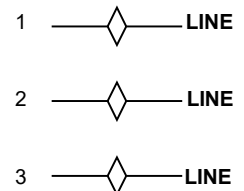

INTERCHANGE ANY TWO LEAD LINES TO REVERSE ROTATION

ASSEMBLY DRAWING
 DR404 DR454 DR513
 DR523 DR505 DR555
 DR606 DR656

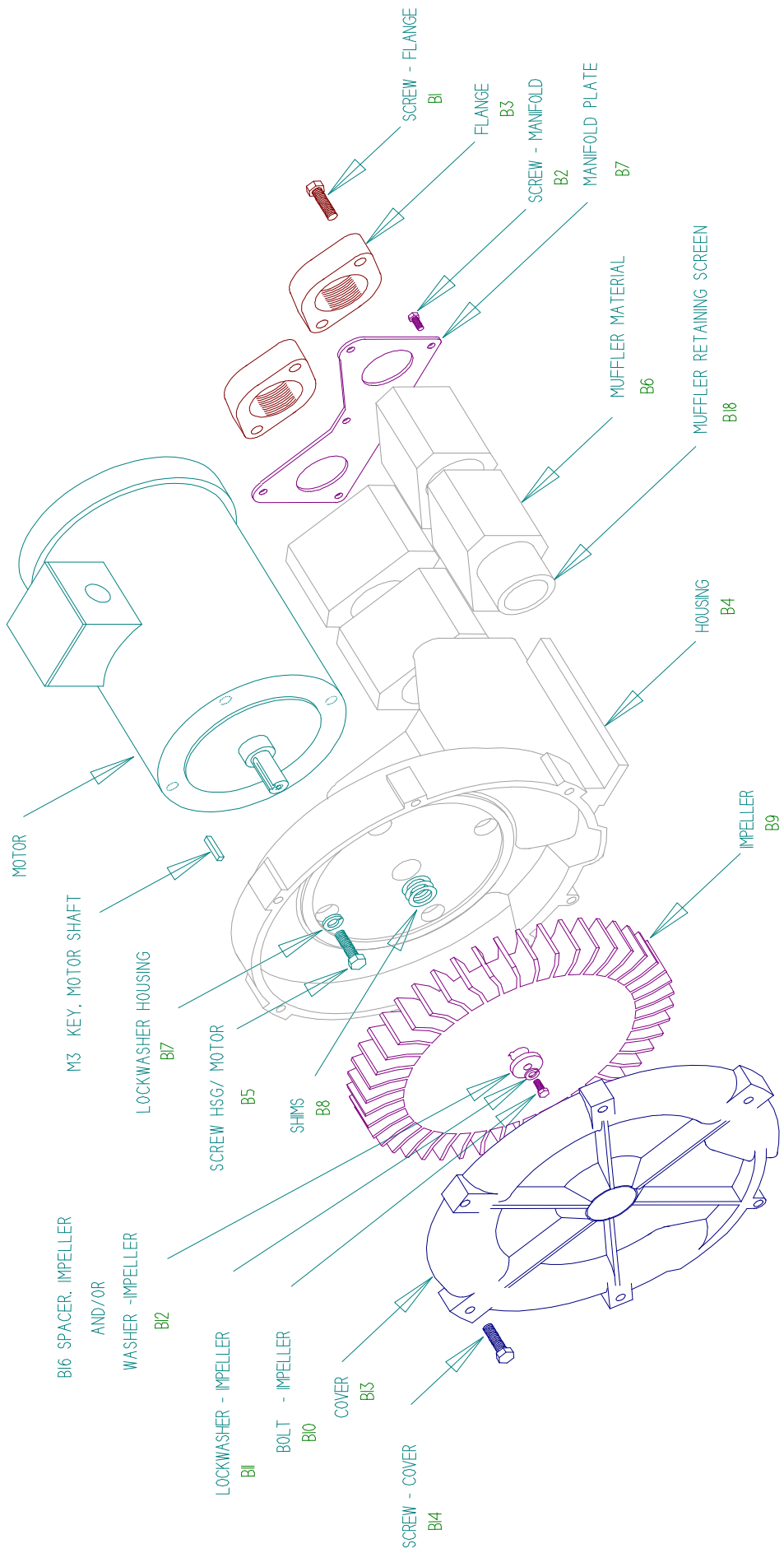

DR 404/454/513/523/505/555/606/656
Service and Parts Manual

Parts Breakdown

Model:
 Part No.:

Item No.	Qty. Req'd	Description	DR404	DR454	DR454	DR513	DR523	DR505	DR555	DR555	DR606
M3	1	Key Motor Shaft	510629	510629	510629	510629	155099	510629	510629	510629	510629
B1	4	Screw, Flange	120162	120162	120162	120162	120162	120162	120162	120162	120255
B2	6	Screw, Manifold	155130	155130	155130 (10 pcs)	120214 (10 pcs)	120214	See Next Page	155170	155477	155477
B3	2	Flange	510962	510354	510354	510354	510354	510354	510354	510354	511480
B4	1	Housing	517002	515737	551001	516552	516551	517419	550195	516721	529790
B5	4	Screw, Hsg/Motor	155128	251791	155128	251791	251791	155128	251791	251791	251791
B6	4	Muffler Material (6 pcs)	517015	515743	515743	516560	516560 (6 pcs)	515743 (8 pcs)	551585	515743	529781
B7	2	Muffler Material	Not Used	Not Used	551006	Not Used	Not Used	Not Used	Not Used	Not Used	Not Used
B7	1	Manifold Plate	517008	515744	515744	529868	529868	See Next Page	551953	517458	511284
B8	*	Shim .002"	510356	510356	510356	510356	500664	510356	510356	510356	510356
B8	*	Shim .005"	510357	510357	510357	510357	500665	510357	510357	510357	510357
B8	*	Shim .010"	510358	510358	510358	510358	500666	510358	510358	510358	510358
B8	*	Shim .020"	510359	510359	510359	510359	500667	510359	510359	510359	510359
B8	*	Shim .030"	Not Used	Not Used	Not Used	Not Used	510292	Not Used	Not Used	Not Used	Not Used
B9	1	Impeller	516987	515675	551067	516557 (2 pcs)	516562	517433	550305	516678	511272
B10	1	Bolt, Impeller	120214	120214	120214	120325	120214	120214	120325	120262	120325
B11	1	Lockwasher, Impeller	120203	120203	120203	120203	120203	120203	120203	120203	120203
B12	1	Washer, Impeller	Not Used	Not Used	Not Used	Not Used	Not Used	Not Used	Not Used	Not Used	Not Used
B13	1	Cover	516990	515702	551065	516559	516559	517431	550249	516675	511274
B14	6	Screw, Cover	155129	155236	155129 (8 pcs)	120255 (8 pcs)	155098	155236 (8 PCS)	155236 (7 pcs)	155236	155236
B16	1	Spacer, Impeller Bolt	510355	510355	510355	510355	510355	510355	510355	510355	510355
B17	4	Lockwasher, Housing	251787	251787	251787	251787	Not Used	251787	251787	251787	251787
B18	2	Screen, Muffler Retaining	517016	551087	551087	511718	511718	See Next Page	551423	510362	517436
B19		Bolt, Muffler Hsg/Hsg	Not Used	Not Used	Not Used	Not Used	Not Used	Not Used	Not Used	Not Used	Not Used
B20		Muffler Housing	Not Used	Not Used	Not Used	Not Used	Not Used	Not Used	Not Used	Not Used	Not Used
		Lip Seal	Not Used	Not Used	Not Used	Not Used	516587	Not Used	Not Used	Not Used	Not Used

OLD New

NEW

OBSOLETE

Model	Part #	Motor	Wiring Diagram	Specific Parts	Bearing, Rear (M1)	Bearing, Impeller End (M2)
DR404AL72M	037406	510438	C			
DR404AL86M	037408	510700	G			
DR404AL58M	037407	510439	A			
DR454R72	036855	510317	C			
DR454R58	036856	510319	A			
DR454R86	036949	516034	G			
DR454CD72	038808	510763	C			
DR454R72M	080480	510317	C	Muffler - Liner (2 pcs) 551006		
DR454R58M	080481	510319	A			
DR454R86M	080482	516034	G			
DR513R72	037217	510317	C			
DR513R58	037209	510319	A			
DR513R86	037773	516034	G			
DR523K72	037210	516571	C			
DR523K58	037211	516572	A	B13A Center Annulus (1 pc) 516555		
DR523K86	037772	551131	G			
DR505CD58M	037546	511307	A			
DR505CD72M	037545	511306	C	B18 517436, B2 155170, B7 517460, B18 517436		
DR505K72M	037551	511306	C			
DR505AS86M	037544	510701	G			
DR505AS72M	037543	510318	C	B2 155130, B7 517458, B18 517435		
DR505AS58M	037542	510320	B			
DR555CK72 - Obsolete	037308	510895	C			
DR555K72 - Obsolete	037306	511306	C			
DR555K58 - Obsolete	037305	511307	A	B2A Washer Manifold (6 pcs) 120222	510449	510217
DR555CK86 - Obsolete	037310	511305	G			
DR555K86 - Obsolete	037309	516686	G			
DR555CK72	081100	510895	C			
DR555K72	081099	511306	C			
DR555K58	081098	511307	A			
DR555CK86	081102	511305	G			
DR555K86	081101	516686	G			
DR606CK72M - Obsolete	038526	510895	C			
DR606K72M - Obsolete	038527	511306	C			
DR606K58M - Obsolete	038529	511307	A			
DR606CK86M - Obsolete	038530	511305	G			
DR606CK58M - Obsolete	038532	516848	F			
DR606D72M - Obsolete	080077	550689	C			
DR656CK72X	080582	510895	C			
DR656CK58X	080584	516848	F			
DR656CK86X	080583	511305	G			
DR656K72X	080602	511306	C	B7* Muffler Extension 551974		
DR656K58X	080603	511307	A			
DR656D72X	080585	550689	C			
DR656D86X	080604	550694	G			

Parts Breakdown

DR656
 080582
 080583
 080604
 080584
 080585
 080602
 080603

Item No.	Qty. Req'd	Description	
M3	1	Key Motor Shaft	510629
B1	4	Screw, Flange	120255
B2	6	Screw, Manifold	155170
B3	2	Flange	511480
B4	1	Housing	550195
B5	4	Screw, Hsg./Motor	251791
B6	4	Muffler Material	(10 pcs) 551585
B7	0	Manifold Plate	Not Used
B8	*	Shim .002"	Not Used
	*	Shim .005"	510356
	*	Shim .010"	510357
	*	Shim .020"	510358
	*	Shim .030"	510359
B9	1	Impeller	Not Used
B10	1	Bolt, Impeller	550305
B11	1	Lockwasher, Impeller	120325
B12	1	Washer, Impeller	120203
B13	1	Cover	Not Used
B14	6	Screw, Cover	550249
B16	1	Spacer, Impeller Bolt	(8 PCS) 155236
B17	4	Lockwasher, Housing	510355
B18	2	Screen, Muffler Retaining	251787
B19		Bolt, Muffler Hsg/Hsg	517436
B20		Muffler Housing	Not Used
		Lip Seal	551974
			Not Used