

SERVICE AND PARTS MANUAL FOR BLOWER MODEL

DR068 – DR353



AMETEK Dynamic Fluid Solutions
100 East Erie St., Kent, Ohio 44240
Telephone: 330-673-3452 Fax: 330-677-3306
email: dfs.information@ametek.com
internet: www.ametekdfs.com

Your Choice. Our Commitment.™

Revised – February 2005

WARRANTY, INSTALLATION, MAINTENANCE AND TROUBLESHOOTING INSTRUCTIONS



AMETEK Dynamic Fluid Solutions
100 East Erie St., Kent, Ohio 44240
Telephone: 330-673-3452 Fax: 330-677-3306
email: dfs.information@ametek.com
internet: www.ametekdfs.com

1. AMETEK Rotron DR, EN and HiE regenerative direct drive blowers are guaranteed for one full year from the date of installation (limited to 18 months from the date of shipment) to the original purchaser only. Should the blower fail we will evaluate the failure. If failure is determined to be workmanship or material defect related, we will at our option repair or replace the blower.
2. AMETEK Rotron Minispiral, Revaflow, Multiflow, Nautilair, remote drive blowers, moisture separators, packaged units, CP blowers, Nasty Gas™ models and special built (EO) products are guaranteed for one full year from date of shipment for workmanship and material defect to the original purchaser only. Should the blower fail, If failure is determined to be workmanship or material defect related, we will at our option repair or replace the blower.
3. **Parts Policy** - AMETEK Rotron spare parts and accessories are guaranteed for three months from date of shipment for workmanship and material defect to the original purchaser only. If failure is determined to be workmanship or material defect related we will at our option repair or replace the part.

Corrective Action - A written report will be provided indicating reason(s) for failure, with suggestions for corrective action. Subsequent customer failures due to abuse, misuse, misapplication or repeat offense will not be covered. AMETEK Rotron will then notify you of your options. Any failed unit that is tampered with by attempting repair or diagnosis will void the warranty, unless authorized by the factory.

Terms and Conditions - Our warranty covers repairs or replacement of regenerative blowers only, and will not cover labor for installation, outbound and inbound shipping costs, accessories or other items not considered integral blower parts. Charges may be incurred on products returned for reasons other than failures covered by their appropriate warranty. Out-of-warranty product and in warranty product returned for failures determined to be caused by abuse, misuse, or repeat offense will be subject to an evaluation charge. Maximum liability will in no case exceed the value of the product purchased. Damage resulting from mishandling during shipment is not covered by this warranty. It is the responsibility of the purchaser to file claims with the carrier. Other terms and conditions of sale are stated on the back of the order acknowledgement.

Installation Instructions for SL, DR, EN, CP, and HiE Series Blowers

1. **Bolt It Down** - Any blower must be secured against movement prior to starting or testing to prevent injury or damage. The blower does not vibrate much more than a standard electric motor.
2. **Filtration** - All blowers should be filtered prior to starting. Care must be taken so that no foreign material enters the blower. If foreign material does enter the blower, it could cause internal damage or may exit at extremely high velocity.

Should excessive amounts of material pass through the blower, it is suggested that the cover(s) and impeller(s) be removed periodically and cleaned to avoid impeller imbalance. Impeller

imbalance greatly speeds bearing wear, thus reducing blower life. Disassembling the blower will void warranty, so contact the factory for cleaning authorization.

- Support the Piping** - The blower flanges and nozzles are designed as connection points only and are not designed to be support members.

Caution: Plastic piping should not be used on blowers larger than 1 HP that are operating near their maximum pressure or suction point. Blower housing and nearby piping temperatures can exceed 200°F. Access by personnel to the blower or nearby piping should be limited, guarded, or marked, to prevent danger of burns.

- Wiring** - Blowlers must be wired and protected/fused in accordance with local and national electrical codes. All blowlers must be grounded to prevent electrical shock. Slo-Blo or time delay fuses should be used to bypass the first second of start-up amperage.
- Pressure/Suction Maximums** - The maximum pressure and/or suction listed on the model label should not be exceeded. This can be monitored by means of a pressure or suction gage (available from Rotron), installed in the piping at the blower outlet or inlet. Also, if problems do arise, the Rotron Field representative will need to know the operating pressure/suction to properly diagnose the problem.
- Excess Air** - Bleed excess air off. DO NOT throttle to reduce flow. When bleeding off excess air, the blower draws less power and runs cooler.

Note: Remote Drive (Motorless) Blowlers - Properly designed and installed guards should be used on all belts, pulleys, couplings, etc. Observe maximum remote drive speed allowable. Due to the range of uses, drive guards are the responsibility of the customer or user. Belts should be tensioned using belt gauge.

Maintenance Procedure

When properly piped, filtered, and applied, little or no routine maintenance is required. Keep the filter clean. Also, all standard models in the DR, EN, CP, and HiE series have sealed bearings that require no maintenance. Bearing should be changed after 15,000 to 20,000 hours, on average. Replacement bearing information is specified on the chart below.

Bearing Part Number	Size	Seal Material	Grease	Heat Stabilized
510217 510218 510219	205 206 207	Polyacrylic	Nye Rheotemp 500 30% +/- 5% Fill	Yes – 325 F
510449 516440 516648	203 202 307	Buna N	Exxon Polyrex Grease	NO
516840 516841 516842 516843 516844 516845 516846 516847	206 207 208 210 309 310 311 313	Buna N	Exxon Polyrex Grease	NO

Troubleshooting

		POSSIBLE CAUSE	OUT OF WARRANTY REMEDY ***
IMPELLER DOES NOT TURN	Humming Sound	<ol style="list-style-type: none"> * One phase of power line not connected * One phase of stator winding open Bearings defective Impeller jammed by foreign material Impeller jammed against housing or cover ** Capacitor open 	<ol style="list-style-type: none"> Connect Rewind or buy new motor Change bearings Clean and add filter Adjust Change capacitor
	No Sound	<ol style="list-style-type: none"> * Two phases of power line not connected * Two phases of stator winding open 	<ol style="list-style-type: none"> Connect Rewind or buy new motor
IMPELLER TURNS	Blown Fuse	<ol style="list-style-type: none"> Insufficient fuse capacity Short circuit 	<ol style="list-style-type: none"> Use time delay fuse of proper rating Repair
	Motor Overheated Or Protector Trips	<ol style="list-style-type: none"> High or low voltage * Operating in single phase condition Bearings defective Impeller rubbing against housing or cover Impeller or air passage clogged by foreign material Unit operating beyond performance range Capacitor shorted * One phase of stator winding short circuited 	<ol style="list-style-type: none"> Check input voltage Check connections Check bearings Adjust Clean and add filter Reduce system pressure/vacuum Change capacitor Rewind or buy new motor
	Abnormal Sound	<ol style="list-style-type: none"> Impeller rubbing against housing or cover Impeller or air passages clogged by foreign material Bearings defective 	<ol style="list-style-type: none"> Adjust Clean and add filter Change bearings
	Performance Below Standard	<ol style="list-style-type: none"> Leak in piping Piping and air passages clogged Impeller rotation reversed Leak in blower Low voltage 	<ol style="list-style-type: none"> Tighten Clean Check wiring Tighten cover, flange Check input voltage
<p>* 3 phase units ** 1 phase units *** Disassembly and repair of new blowers or motors will void the Rotron warranty. Factory should be contacted prior to any attempt to field repair an in-warranty unit.</p>			

Blower Disassembly:

WARNING: Attempting to repair or diagnose a blower may void Rotron's warranty. It may also be difficult to successfully disassemble and reassemble the unit.

- 1) Disconnect the power leads. **CAUTION:** Be sure the power is disconnected before doing any work whatsoever on the unit.
- 2) Remove or separate piping and/or mufflers and filters from the unit.
- 3) Remove the cover bolts and then the cover. **NOTE:** Some units are equipped with seals. It is mandatory that these seals be replaced once the unit has been opened.
- 4) Remove the impeller bolt and washers and then remove the impeller. **NOTE:** Never pry on the edges of the impeller. Use a puller as necessary.
- 5) Carefully note the number and location of the shims. Remove and set them aside. **NOTE:** If the disassembly was for inspection and cleaning the unit may now be reassembled by reversing the above steps. If motor servicing or replacement and/or impeller replacement is required the same shims may not be used. It will be necessary to re-shim the impeller according to the procedure explained under assembly.

- 6) Remove the housing bolts and remove the motor assembly (arbor/housing on remote drive models).
- 7) Arbor disassembly (Applicable on remote drive models only):
 - a) Slide the bearing retraining sleeve off the shaft at the blower end.
 - b) Remove the four (4) screws and the bearing retaining plate from the blower end.
 - c) Lift the shaft assembly far enough out of the arbor to allow removal of the blower end snap ring.
 - d) Remove the shaft assembly from the arbor.
 - e) If necessary, remove the shaft dust seal from the pulley end of the arbor.

Muffler Material Replacement:

- 1) Remove the manifold cover bolts and them manifold cover.
- 2) The muffler material can now be removed and replaced if necessary. On blowers with fiberglass acoustical wrap the tubular retaining screens with the fiberglass matting before sliding the muffler pads over the screens.
- 3) Reassemble by reversing the procedure.

NOTE: On DR068 models with tubular mufflers it is necessary to remove the cover and impeller accessing the muffler material from the housing cavity.

Blower Reassembly:

- 1) Place the assembled motor (assembled arbor assembly for remote drive models) against the rear of the housing and fasten with the bolts and washer.
- 2) To ensure the impeller is centered within the housing cavity re-shim the impeller according to the procedure outlined below.
- 3) If blower had a seal replace the seal with a new one.
- 4) Place the impeller onto the shaft making sure the shaft key is in place and fasten with the bolt, washer and spacer as applicable. Torque the impeller bolt per the table below. Once fastened carefully rotate the impeller to be sure it turns freely.
- 5) Replace the cover and fasten with bolts.
- 6) Reconnect the power leads to the motor per the motor nameplate.

Bolt Size	Torque Pound-Force-Foot
1/4-20	6.25 +/- 0.25
5/16-18	11.5 +/- 0.25
3/8-16	20.0 +/- 0.5
1/2-13	49.0 +/- 1
5/8 -11	90.0 +/- 2

Impeller Shimming Procedure:

WARNING: This unit may be difficult to shim. Extreme care may be exercised.

Tools Needed: Machinist's Parallel Bar
Vernier Caliper with depth measuring capability
Feeler gauges or depth gauge

Measure the Following:

- Distance from the flange face to the housing (A)
- Distance from the flange face to the motor shaft shoulder (B)
- Impeller Thickness (C)

Measurements (A) and (B) are made by laying the parallel bar across the housing flange face and measuring to the proper points. Each measurement should be made at three points, and the average of the readings should be used.

$$\text{Shim Thickness} = B - (A+C)/2$$

After the impeller installation (step #4 above) the impeller/cover clearance can be checked with feeler gauges, laying the parallel bar across the housing flange face. This clearance should nominally be $(A-C)/2$.

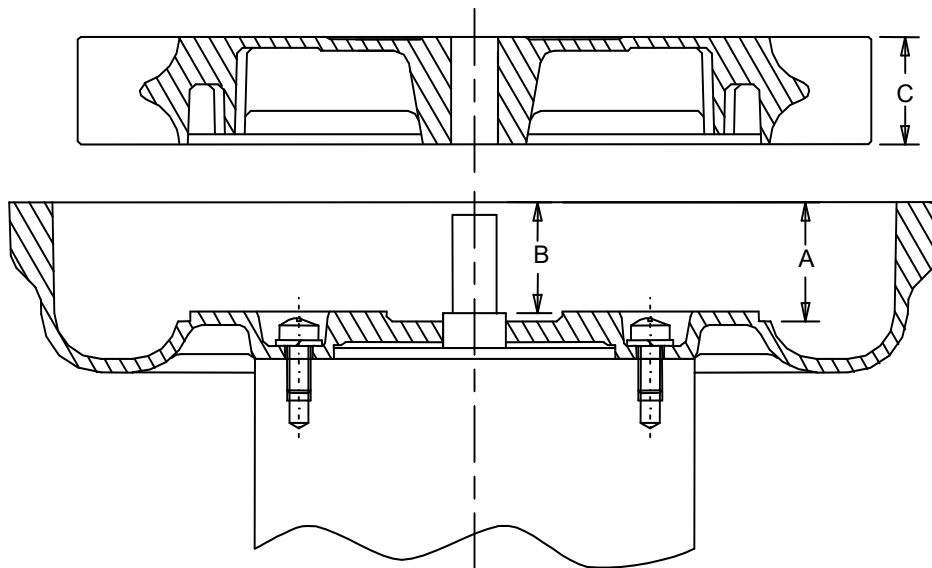

WIRING DIAGRAMS, TEFC and ODP MOTORS

A. 1Ø, 6 WIRE

115 VAC

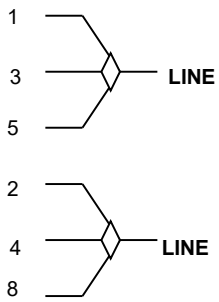

230 VAC

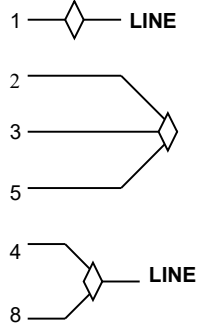

INTERCHANGE LEADWIRES 5 & 8 to REVERSE ROTATION

B. 1Ø, 7 WIRE

115 VAC

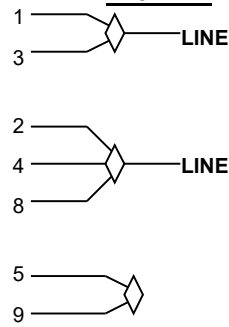

230 VAC

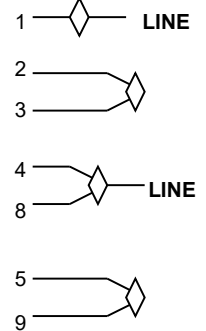

INTERCHANGE LEADWIRES 5 & 8 to REVERSE ROTATION

C. 3Ø, 9 WIRE

230 VAC

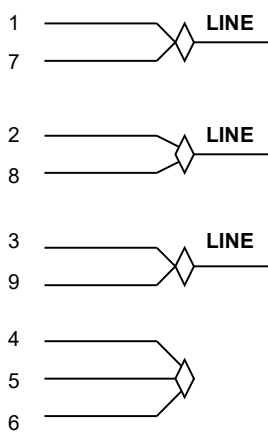

460 VAC

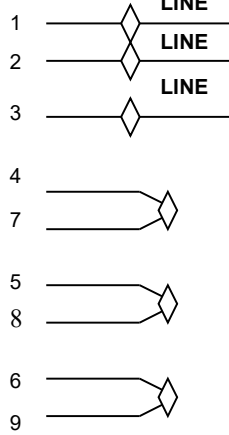

INTERCHANGE ANY TWO LEAD LINES TO REVERSE ROTATION

D. 1Ø, EMERSON 1/8 HP MOTOR

115 VAC

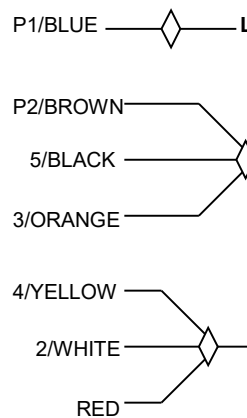

230 VAC

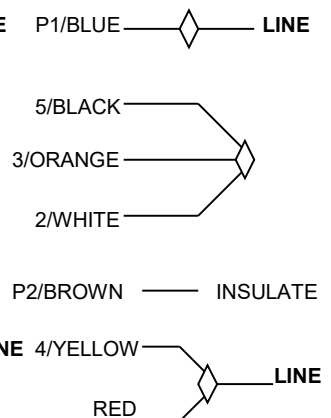

INTERCHANGE RED AND BLACK TO REVERSE ROTATION

E. 1Ø, SPA DUTY WITH TERMINAL STRIPS

LOW 115 VAC

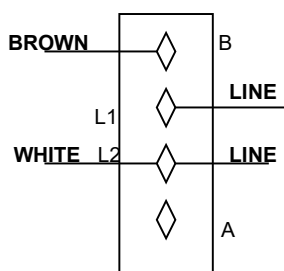

HIGH 230 VAC

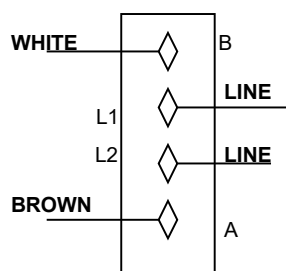

F. 1Ø, 230 VAC

SINGLE VOLTAGE

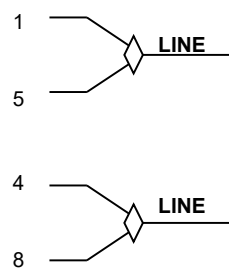

INTERCHANGE LEAD WIRES 5 & 8 TO REVERSE ROTATION

G. 3Ø, 575 VAC

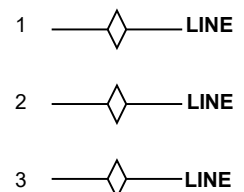

INTERCHANGE ANY TWO LEAD LINES TO REVERSE ROTATION

DR 068/083/101
Service and Parts Manual

Model:	DR068DJ9Y	DR068DJ9Y	DR083DC9Y	DR101
Part No.:	037143	037326	036862	036244
	081657		081572	036245
				036672
	OBSOLETE			OBSOLETE

Item No.	Qty.	Req'd Description				
M3	1	Key Motor Shaft	155045	155045	155045	511501
B1	4	Screw, Flange	Not Used	Not Used	Not Used	120325
B2	6	Screw, Manifold	155477	Not Used	155477	120303
B3	2	Flange	Not Used	Not Used	Not Used	515212
B4	1	Housing	See next page	516714	552412	510347
B5	4	Screw, Hsg /Motor	See next page	155043	see next page	121925
B6	4	Muffler Material	515779	(2 pcs)516720	516427	510544
B7	1	Manifold Plate	516373	Not Used	515654	510541
B8	*	Shim .002"	516360	510360	516360	510494
	*	Shim .005"	516361	510361	516361	510495
	*	Shim .010"	516362	510362	516362	510496
	*	Shim .020"	Not Used	Not Used	Not Used	155411
	*	Shim .030"	Not Used	Not Used	Not Used	155412
B9	1	Impeller	516631	516631	516416	510351
B10	1	Bolt, Impeller	155551	155551	155551	120118
B11	1	Lockwasher, Impeller	251690	251690	251690	120203
B12	1	Washer, Impeller	595332	595332	595332	Not Used
B13	1	Cover	515778	516718	515698	510349
B14	6	Screw, Cover	(5 pcs)155424	(5 pcs)120231	(5 pcs)155424	120232
B16	1	Spacer, Impeller Bolt	Not Used	Not Used	Not Used	510355
B17	4	Lockwasher, Housing	See next page	140009	see next page	120203
B18		Screen, Muffler Retaining	Not Used	Not Used	Not Used	Not Used
B19		Bolt, Muffler Hsg/Hsg	Not Used	Not Used	Not Used	Not Used
B20		Muffler Housing	Not Used	Not Used	Not Used	Not Used
		Bolt, Motor/Muffler	Not Used	Not Used	Not Used	Not Used
		Lockwasher, Motor/Muffler	Not Used	Not Used	Not Used	Not Used
		Washer, Motor/Muffler	Not Used	Not Used	Not Used	Not Used
		Spacer, Motor/Muffler	Not Used	Not Used	Not Used	Not Used

Model	Part #	Motor	Wiring	Specific Parts
DR068DJ9Y	081657	552391	see motor	B4 552411, B5 251493 B17 120203
DR068DJ9Y	037143	515729	D	B4 515784, B5 155043, B17 140009
DR068DJ9Y	037326	515730	D	
DR083DC9Y	081572	552391	see motor	B4 552412, B5 251493, B17 120203
DR083DC9Y	036862	515729	D	B4 515709, B5 121925, B17 140009
DR101DC9	037252	515729	D	
DR101BX9	036244	510498	A	
DR101BX72	036245	517356	C	
DR101BX86	036672	515211	G	
DR101DC9M	038939	515729	D	
DR101BX9M	038936	510498	A	
DR101BX72M	038937	510501	C	
DR101BX86M	038938	516610	G	

Parts Breakdown

DR101	DR101	DR101
038936	037252	038939
038937		
038938		
	OBSOLETE	

Item No.	Qty. Req'd	Description			
M3	1	Key Motor Shaft	511501	155045	155045
B1	4	Screw, Flange	120262	120262	120262
B2	6	Screw, Manifold	155423	120303	155423
B3	2	Flange	510480	515212	510480
B4	1	Housing	550421	516616	550423
B5	4	Screw, Hsg /Motor	121925	121925	155043
B6	4	Muffler Material (6 Pcs)	510544	510544 (6 Pcs)	510544
B7	1	Manifold Plate	510541	510541	510541
B8	*	Shim .002"	510494	516360	516360
	*	Shim .005"	510495	516361	516361
	*	Shim .010"	510496	516362	516362
	*	Shim .020"	155411	155411	Not Used
	*	Shim .030"	155412	155412	Not Used
B9	1	Impeller	550410	516617	550412
B10	1	Bolt, Impeller	120118	120237	120237
B11	1	Lockwasher, Impeller	120203	251690	251690
B12	1	Washer, Impeller	Not Used	Not Used	Not Used
B13	1	Cover	550623	510349	550623
B14	6	Screw, Cover	155424	120232	155424
B16	1	Spacer, Impeller Bolt	510355	155115	155115
B17	4	Lockwasher, Housing	120203	140009	140009
B18		Screen, Muffler Retainin:	Not Used	Not Used	Not Used
B19		Bolt, Muffler Hsg/Hsg	Not Used	Not Used	Not Used
B20		Muffler Housing	Not Used	Not Used	Not Used
		Bolt, Motor/Muffler	Not Used	Not Used	Not Used
		Lockwasher, Motor/Muffl	Not Used	Not Used	Not Used
		Washer, Motor/Muffler	Not Used	Not Used	Not Used
		Spacer, Motor/Muffler	Not Used	Not Used	Not Used

*As needed **Viewed looking at inlet/outlet ports

Bearing,Rear (M1)	Bearing,
Not Replaceable	Not Replaceable
Not Replaceable	Not Replaceable
510449	510449
Not Replaceable	Not Replaceable
510449	510449

DR 202/202M/303/353/353M
Service and Parts Manual

Parts Breakdown

Model:	DR202	DR202M	DR303	DR303	DR353M
Part No.:	037066	080564	036699	038841	037146
	037067	080565	036698	038842	037147
	036373	080566	037207	038843	037148
			OBSOLETE		OBSOLETE

Item No.	Qty.	Req'd Description	DR202	DR202M	DR303	DR303	DR353M
M3	1	Key Motor Shaft	511501	511501	511501	515582	510629
B1	4	Screw, Flange	120214	155425	120162	120162	120162
B2	6	Screw, Manifold	155477	155423	120303	155477	155130
B3	2	Flange	510480	510493	510493	510493	510962
B4	1	Housing	510341	550173	510335	550173	517002
B5	4	Screw, Hsg/Motor	120235	121925	121925	121925	155128
B6	4	Muffler Material	510485	550186	510488	550186	516384 (6 pcs) 517015
B7	1	Manifold Plate	510478	Not Used	510487	Not Used	516347 517008
B8	*	Shim .002"	510494	510494	510494	510494	510356
	*	Shim .005"	510495	510495	510495	510495	510357
	*	Shim .010"	510496	510496	510496	510496	510358
	*	Shim .020"	155411	155411	155411	155411	510359
	*	Shim .030"	155412	155412	155412	155412	Not Used
B9	1	Impeller	510345	551222	510339	529888	551223
B10	1	Bolt, Impeller	120118	120214	120118	120214	120214
B11	1	Lockwasher, Impeller	120203	120203	120203	120203	120203
B12	1	Washer, Impeller	Not Used	Not Used	Not Used	Not Used	Not Used
B13	1	Cover	510343	550132	510337	550132	516990
B14	6	Screw, Cover	155424	155424	120232	155424 (5 pcs) 155129	155129
B16	1	Spacer, Impeller Bolt	510355	510355	510355	510355	510355
B17	4	Lockwasher, Housing	120203	120203	120203	120203	251787
B18		Screen, Muffler Retaining Right (**)	Not Used	Not Used	Not Used	Not Used	517016
		Screen, Muffler Retaining, Left (**)	Not Used	Not Used	Not Used	Not Used	517016
B19		Bolt, Muffler Hsg/Hsg	Not Used	Not Used	Not Used	Not Used	Not Used
B20	1	Muffler Housing	Integral	550170	Integral	550170	Not Used
		Bolt, Motor/Muffler	Not Used	Not Used	Not Used	Not Used	Not Used
		Lockwasher, Motor/Muffler	Not Used	Not Used	Not Used	Not Used	Not Used
		Washer, Motor/Muffler	Not Used	Not Used	Not Used	Not Used	Not Used
		Spacer, Motor/Muffler	Not Used	Not Used	Not Used	Not Used	Not Used

*As needed **Viewed looking at inlet/outlet ports

Model	Part #	Motor	Wiring Diagram	Specific Parts	Bearing Rear (M1)	Bearing, Impeller End (M2)
DR202Y9	037066	510498	A			
DR202Y72	037067	510501	C			
DR202Y86	036373	516610	G			
DR202Y9M	080564	510498	A			
DR202Y72M	080565	510501	C			
DR202Y86M	080566	510933	G			
DR303AE9	036699	517355	A			
DR303AE72	036698	517356	C			
DR303AE86	037207	516610	G			
DR303AE9M	038841	517355	A			
DR303AE72M	038842	517356	C			
DR303AE86M	038843	516610	G			
DR353BR86	037146	510934	G			
DR353BR9	037147	510499	A			
DR353BR72	037148	510502	C			
DR353BR86M	080556	551237	G			
DR353BR9M	080554	551235	A			
DR353BR72M	080555	551236	C			

*As needed **Viewed looking at inlet/outlet ports