

SERVICE AND PARTS MANUAL FOR BLOWER MODEL

CP6, CP858, CP909, CP14

DIRECT DRIVE

REGENERATIVE BLOWER

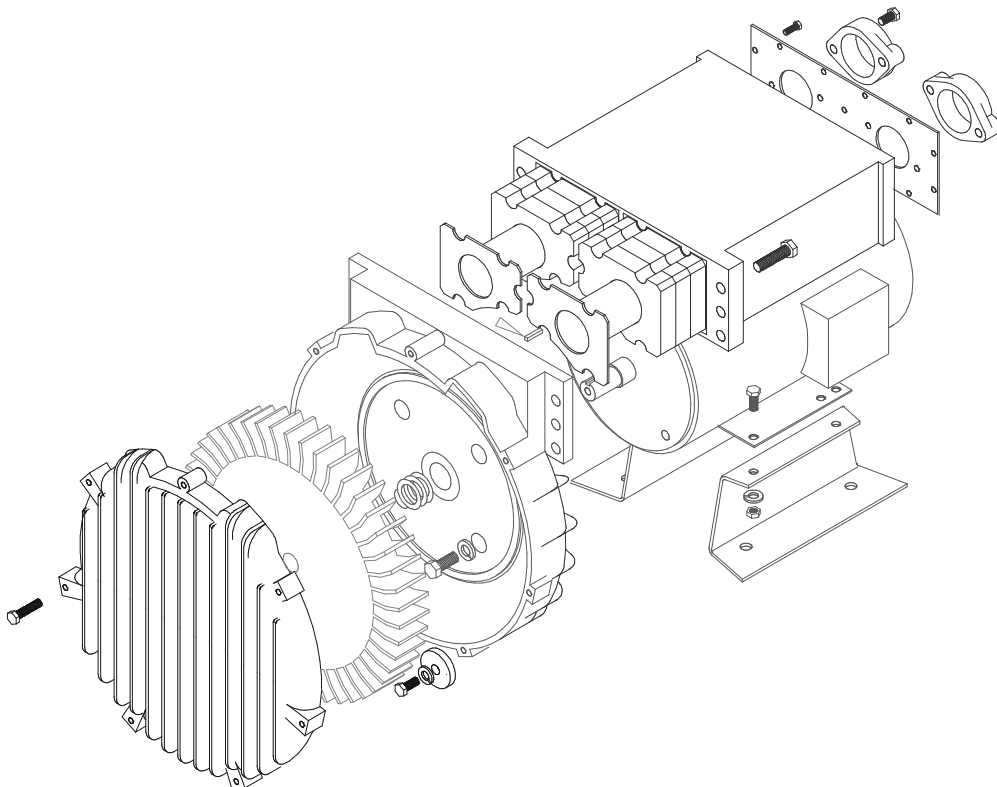

AMETEK

AMETEK Dynamic Fluid Solutions
100 East Erie St., Kent, Ohio 44240
Telephone: 330-673-3452 Fax: 330-677-3306
email: dfs.information@ametek.com
internet: www.ametekdfs.com

Your Choice. Our Commitment.™

WARRANTY, INSTALLATION, MAINTENANCE AND TROUBLESHOOTING INSTRUCTIONS



AMETEK Dynamic Fluid Solutions
100 East Erie St., Kent, Ohio 44240
Telephone: 330-673-3452 Fax: 330-677-3306
email: dfs.information@ametek.com
internet: www.ametekdfs.com

1. AMETEK Rotron DR, EN and HiE regenerative direct drive blowers are guaranteed for one full year from the date of installation (limited to 18 months from the date of shipment) to the original purchaser only. Should the blower fail we will evaluate the failure. If failure is determined to be workmanship or material defect related, we will at our option repair or replace the blower.
2. AMETEK Rotron Minispiral, Revaflow, Multiflow, Nautilair, remote drive blowers, moisture separators, packaged units, CP blowers, Nasty Gas™ models and special built (EO) products are guaranteed for one full year from date of shipment for workmanship and material defect to the original purchaser only. Should the blower fail, If failure is determined to be workmanship or material defect related, we will at our option repair or replace the blower.
3. **Parts Policy** - AMETEK Rotron spare parts and accessories are guaranteed for three months from date of shipment for workmanship and material defect to the original purchaser only. If failure is determined to be workmanship or material defect related we will at our option repair or replace the part.

Corrective Action - A written report will be provided indicating reason(s) for failure, with suggestions for corrective action. Subsequent customer failures due to abuse, misuse, misapplication or repeat offense will not be covered. AMETEK Rotron will then notify you of your options. Any failed unit that is tampered with by attempting repair or diagnosis will void the warranty, unless authorized by the factory.

Terms and Conditions - Our warranty covers repairs or replacement of regenerative blowers only, and will not cover labor for installation, outbound and inbound shipping costs, accessories or other items not considered integral blower parts. Charges may be incurred on products returned for reasons other than failures covered by their appropriate warranty. Out-of-warranty product and in warranty product returned for failures determined to be caused by abuse, misuse, or repeat offense will be subject to an evaluation charge. Maximum liability will in no case exceed the value of the product purchased. Damage resulting from mishandling during shipment is not covered by this warranty. It is the responsibility of the purchaser to file claims with the carrier. Other terms and conditions of sale are stated on the back of the order acknowledgement.

Installation Instructions for SL, DR, EN, CP, and HiE Series Blowers

1. **Bolt It Down** - Any blower must be secured against movement prior to starting or testing to prevent injury or damage. The blower does not vibrate much more than a standard electric motor.
2. **Filtration** - All blowers should be filtered prior to starting. Care must be taken so that no foreign material enters the blower. If foreign material does enter the blower, it could cause internal damage or may exit at extremely high velocity.

Should excessive amounts of material pass through the blower, it is suggested that the cover(s) and impeller(s) be removed periodically and cleaned to avoid impeller imbalance. Impeller

imbalance greatly speeds bearing wear, thus reducing blower life. Disassembling the blower will void warranty, so contact the factory for cleaning authorization.

- Support the Piping** - The blower flanges and nozzles are designed as connection points only and are not designed to be support members.

Caution: Plastic piping should not be used on blowers larger than 1 HP that are operating near their maximum pressure or suction point. Blower housing and nearby piping temperatures can exceed 200°F. Access by personnel to the blower or nearby piping should be limited, guarded, or marked, to prevent danger of burns.

- Wiring** - Blowlers must be wired and protected/fused in accordance with local and national electrical codes. All blowlers must be grounded to prevent electrical shock. Slo-Blo or time delay fuses should be used to bypass the first second of start-up amperage.
- Pressure/Suction Maximums** - The maximum pressure and/or suction listed on the model label should not be exceeded. This can be monitored by means of a pressure or suction gage (available from Rotron), installed in the piping at the blower outlet or inlet. Also, if problems do arise, the Rotron Field representative will need to know the operating pressure/suction to properly diagnose the problem.
- Excess Air** - Bleed excess air off. DO NOT throttle to reduce flow. When bleeding off excess air, the blower draws less power and runs cooler.

Note: Remote Drive (Motorless) Blowlers - Properly designed and installed guards should be used on all belts, pulleys, couplings, etc. Observe maximum remote drive speed allowable. Due to the range of uses, drive guards are the responsibility of the customer or user. Belts should be tensioned using belt gauge.

Maintenance Procedure

When properly piped, filtered, and applied, little or no routine maintenance is required. Keep the filter clean. Also, all standard models in the DR, EN, CP, and HiE series have sealed bearings that require no maintenance. Bearing should be changed after 15,000 to 20,000 hours, on average. Replacement bearing information is specified on the chart below.

Bearing Part Number	Size	Seal Material	Grease	Heat Stabilized
510217 510218 510219	205 206 207	Polyacrylic	Nye Rheotemp 500 30% +/- 5% Fill	Yes – 325 F
510449 516440 516648	203 202 307	Buna N	Exxon Polyrex Grease	NO
516840 516841 516842 516843 516844 516845 516846 516847	206 207 208 210 309 310 311 313	Buna N	Exxon Polyrex Grease	NO

Troubleshooting

		POSSIBLE CAUSE	OUT OF WARRANTY REMEDY ***
IMPELLER DOES NOT TURN	Humming Sound	<ol style="list-style-type: none"> * One phase of power line not connected * One phase of stator winding open Bearings defective Impeller jammed by foreign material Impeller jammed against housing or cover ** Capacitor open 	<ol style="list-style-type: none"> Connect Rewind or buy new motor Change bearings Clean and add filter Adjust Change capacitor
	No Sound	<ol style="list-style-type: none"> * Two phases of power line not connected * Two phases of stator winding open 	<ol style="list-style-type: none"> Connect Rewind or buy new motor
IMPELLER TURNS	Blown Fuse	<ol style="list-style-type: none"> Insufficient fuse capacity Short circuit 	<ol style="list-style-type: none"> Use time delay fuse of proper rating Repair
	Motor Overheated Or Protector Trips	<ol style="list-style-type: none"> High or low voltage * Operating in single phase condition Bearings defective Impeller rubbing against housing or cover Impeller or air passage clogged by foreign material Unit operating beyond performance range Capacitor shorted * One phase of stator winding short circuited 	<ol style="list-style-type: none"> Check input voltage Check connections Check bearings Adjust Clean and add filter Reduce system pressure/vacuum Change capacitor Rewind or buy new motor
	Abnormal Sound	<ol style="list-style-type: none"> Impeller rubbing against housing or cover Impeller or air passages clogged by foreign material Bearings defective 	<ol style="list-style-type: none"> Adjust Clean and add filter Change bearings
	Performance Below Standard	<ol style="list-style-type: none"> Leak in piping Piping and air passages clogged Impeller rotation reversed Leak in blower Low voltage 	<ol style="list-style-type: none"> Tighten Clean Check wiring Tighten cover, flange Check input voltage
<p>* 3 phase units ** 1 phase units *** Disassembly and repair of new blowers or motors will void the Rotron warranty. Factory should be contacted prior to any attempt to field repair an in-warranty unit.</p>			

Blower Disassembly:

WARNING: Attempting to repair or diagnose a blower may void Rotron's warranty. It may also be difficult to successfully disassemble and reassemble the unit.

- 1) Disconnect the power leads. **CAUTION:** Be sure the power is disconnected before doing any work whatsoever on the unit.
- 2) Remove or separate piping and/or mufflers and filters from the unit.
- 3) Remove the cover bolts and then the cover. **NOTE:** Some units are equipped with seals. It is mandatory that these seals be replaced once the unit has been opened.
- 4) Remove the impeller bolt and washers and then remove the impeller. **NOTE:** Never pry on the edges of the impeller. Use a puller as necessary.
- 5) Carefully note the number and location of the shims. Remove and set them aside. **NOTE:** If the disassembly was for inspection and cleaning the unit may now be reassembled by reversing the above steps. If motor servicing or replacement and/or impeller replacement is required the same shims may not be used. It will be necessary to re-shim the impeller according to the procedure explained under assembly.

- 6) Remove the housing bolts and remove the motor assembly (arbor/housing on remote drive models).
- 7) Arbor disassembly (Applicable on remote drive models only):
 - a) Slide the bearing retraining sleeve off the shaft at the blower end.
 - b) Remove the four (4) screws and the bearing retaining plate from the blower end.
 - c) Lift the shaft assembly far enough out of the arbor to allow removal of the blower end snap ring.
 - d) Remove the shaft assembly from the arbor.
 - e) If necessary, remove the shaft dust seal from the pulley end of the arbor.

Muffler Material Replacement:

- 1) Remove the manifold cover bolts and them manifold cover.
- 2) The muffler material can now be removed and replaced if necessary. On blowers with fiberglass acoustical wrap the tubular retaining screens with the fiberglass matting before sliding the muffler pads over the screens.
- 3) Reassemble by reversing the procedure.

NOTE: On DR068 models with tubular mufflers it is necessary to remove the cover and impeller accessing the muffler material from the housing cavity.

Blower Reassembly:

- 1) Place the assembled motor (assembled arbor assembly for remote drive models) against the rear of the housing and fasten with the bolts and washer.
- 2) To ensure the impeller is centered within the housing cavity re-shim the impeller according to the procedure outlined below.
- 3) If blower had a seal replace the seal with a new one.
- 4) Place the impeller onto the shaft making sure the shaft key is in place and fasten with the bolt, washer and spacer as applicable. Torque the impeller bolt per the table below. Once fastened carefully rotate the impeller to be sure it turns freely.
- 5) Replace the cover and fasten with bolts.
- 6) Reconnect the power leads to the motor per the motor nameplate.

Bolt Size	Torque Pound-Force-Foot
1/4-20	6.25 +/- 0.25
5/16-18	11.5 +/- 0.25
3/8-16	20.0 +/- 0.5
1/2-13	49.0 +/- 1
5/8 -11	90.0 +/- 2

Impeller Shimming Procedure:

WARNING: This unit may be difficult to shim. Extreme care may be exercised.

Tools Needed: Machinist's Parallel Bar
Vernier Caliper with depth measuring capability
Feeler gauges or depth gauge

Measure the Following:

- Distance from the flange face to the housing (A)
- Distance from the flange face to the motor shaft shoulder (B)
- Impeller Thickness (C)

Measurements (A) and (B) are made by laying the parallel bar across the housing flange face and measuring to the proper points. Each measurement should be made at three points, and the average of the readings should be used.

$$\text{Shim Thickness} = B - (A+C)/2$$

After the impeller installation (step #4 above) the impeller/cover clearance can be checked with feeler gauges, laying the parallel bar across the housing flange face. This clearance should nominally be (A-C)/2.

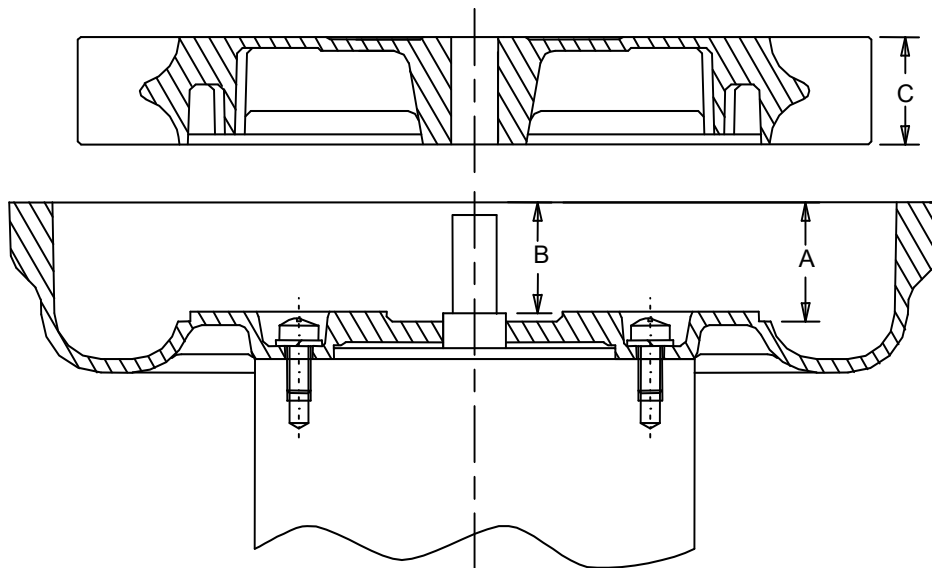

WIRING DIAGRAMS, TEFC and ODP MOTORS

A. 1Ø, 6 WIRE

115 VAC

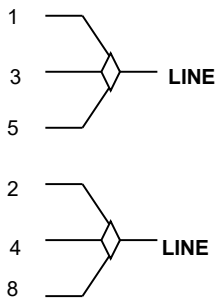

230 VAC

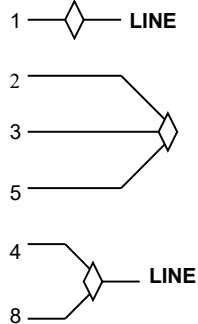

INTERCHANGE LEADWIRES 5 & 8 to REVERSE ROTATION

B. 1Ø, 7 WIRE

115 VAC

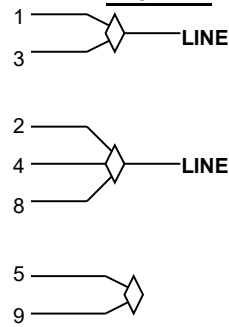

230 VAC

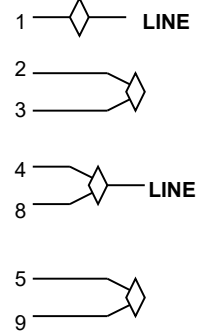

INTERCHANGE LEADWIRES 5 & 8 to REVERSE ROTATION

C. 3Ø, 9 WIRE

230 VAC

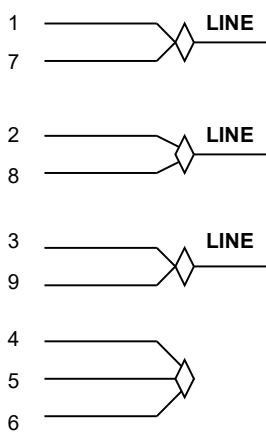

460 VAC

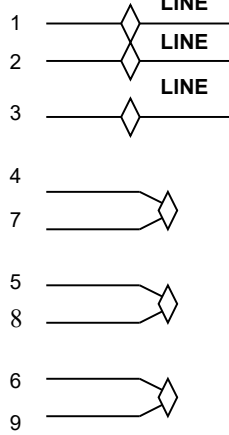

INTERCHANGE ANY TWO LEAD LINES TO REVERSE ROTATION

D. 1Ø, EMERSON 1/8 HP MOTOR

115 VAC

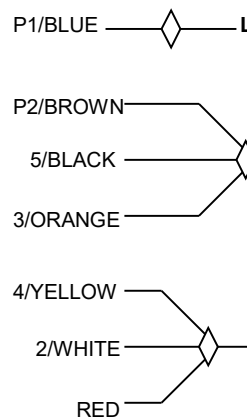

230 VAC

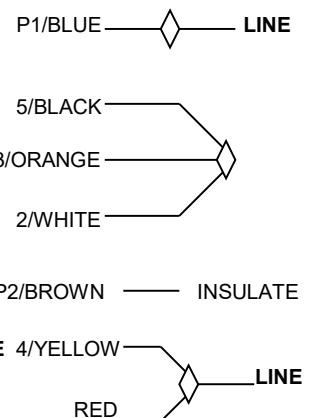

INTERCHANGE RED AND BLACK TO REVERSE ROTATION

E. 1Ø, SPA DUTY WITH TERMINAL STRIPS

LOW 115 VAC

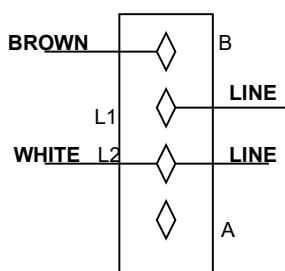

HIGH 230 VAC

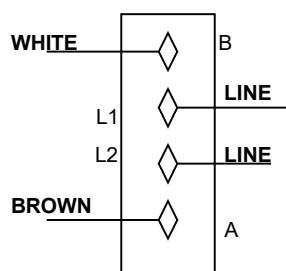

F. 1Ø, 230 VAC

SINGLE VOLTAGE

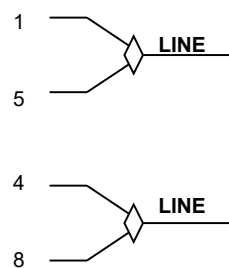

INTERCHANGE LEAD WIRES 5 & 8 TO REVERSE ROTATION

G. 3Ø, 575 VAC

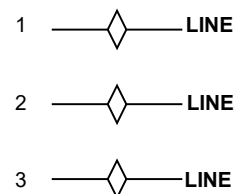

INTERCHANGE ANY TWO LEAD LINES TO REVERSE ROTATION

AMETEK Dynamic Fluid Solutions .

100 East Erie St., Kent, Ohio 44240
 Telephone: 330-673-3452 Fax: 330-677-3306
 email: dfs.information@ametek.com
 internet: www.ametekdfs.com

EXPLOSION-PROOF BLOWERS



IMPORTANT: Read before wiring this Explosion-proof Blower

This AMETEK Rotron Explosion-proof Regenerative Blower may be equipped with Pilot Duty Thermal Overload (PDTO) or Automatic Thermal Overload (ATO) protection. When properly wired to a motor starter, this protection limits the motor winding temperature rise per the National Electric Code (NEC) article 500. Failure to properly wire this blower is an NEC violation and could cause an explosion. AMETEK Rotron assumes no responsibilities for damages incurred by negligent use of this product, and will not warranty a blower on which the PDTO is not properly connected. Some blowers 1 HP and under do not require PDTO and have built in ATO. Consult the factory if verification of wiring connections is required.

In all cases, follow the motor controller manufacturer’s instructions. The following schematic is for conceptual understanding only, and may not apply to all motor/controller combinations.

The manufacturer’s wiring diagram found on the motor takes precedent over reference diagrams supplied by AMETEK Rotron Technical Motor Division.

Schematic

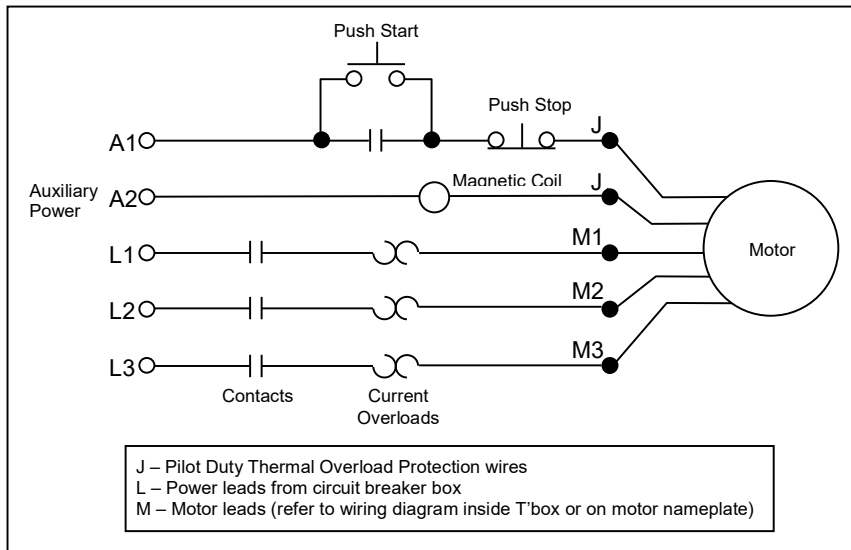

The schematic is shown for a three phase motor. For a single phase motor disregard L3 and M3. Pushing the START button completes the auxiliary control circuit, allowing current to flow through the magnetic coil. The contacts are magnetically closed, starting the motor and latching the auxiliary circuit. The motor will continue to run until the STOP push button is depressed, the motor reaches the overload temperature, or the current sensing overloads trip out.

If you have any questions, contact AMETEK Rotron at 914-246-3401 for the location of your area representative.

POLICY REGARDING INSTALLATION OF AMETEK ROTRON REGENERATIVE BLOWERS IN HAZARDOUS LOCATIONS

AMETEK Rotron will not knowingly specify, design or build any regenerative blower for installation in a hazardous, explosive location without the proper NEMA motor enclosure. AMETEK Rotron does not recognize sealed blowers as a substitute for explosion-proof motors. Sealed units with standard TEFC motors should never be utilized where local, state, and/or federal codes specify the use of explosion-proof equipment.

AMETEK Rotron has a complete line of regenerative blowers with explosion-proof motors. Division 1 & 2, Class I, Group D; Class II, Groups F & G requirements are met with these standard explosion-proof blowers.

AMETEK Rotron will not knowingly specify, design or build any regenerative blower for installation in a hazardous, corrosive environment without the proper surface treatment and sealing options.

AMETEK Rotron has a complete line of Chemical Processing and Nasty Gas™ regenerative blowers with Chem-Tough™, stainless steel parts, and seals.

AMETEK Rotron offers general application guidance; however, suitability of the particular blower selection is ultimately the responsibility of the purchaser, not the manufacturer of the blower.

FS2 Rev B 3/10/98

WIRING DIAGRAMS, XP MOTORS

H. 1Ø, 6 WIRE

115 VAC

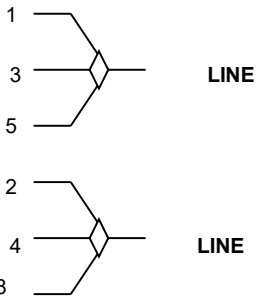

230 VAC

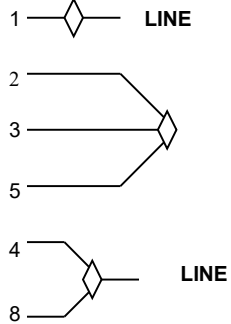

INTERCHANGE LEADWIRES 5 & 8 to REVERSE ROTATION

I. 1Ø, 7 WIRE

115 VAC

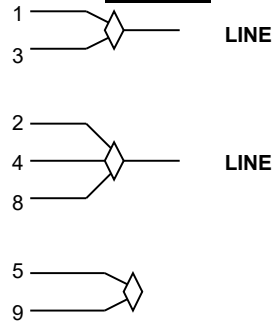

230 VAC

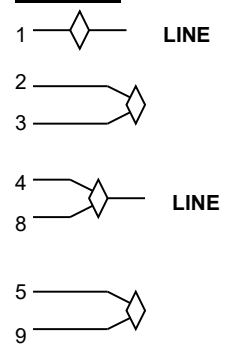

INTERCHANGE LEADWIRES 5 & 8 to REVERSE ROTATION

K. 3Ø, 9 WIRE

230 VAC

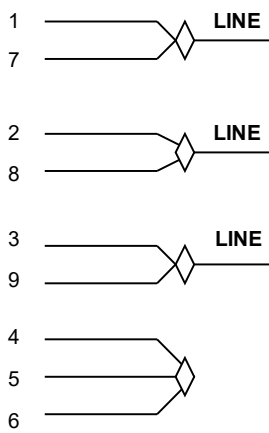

460 VAC

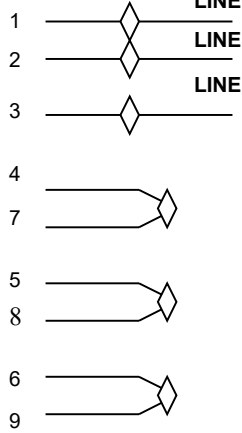

INTERCHANGE ANY TWO LEAD LINES TO REVERSE ROTATION

L. PILOT DUTY THERMAL OVERLOADS

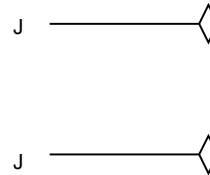

HOOK J LEADS TO CONTROL CIRCUITRY

M. 1Ø 230 VAC

SINGLE VOLTAGE

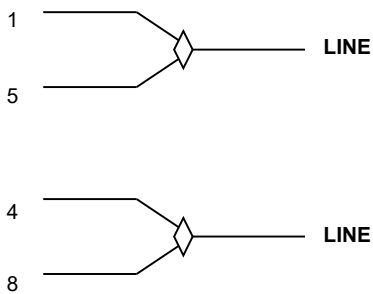

INTERCHANGE LEADWIRES 5 & 8 TO REVERSE ROTATION

N. 3Ø 575 VAC

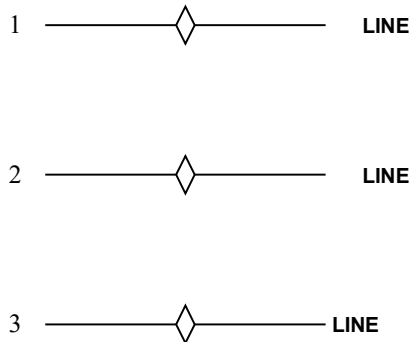

INTERCHANGE ANY TWO LEAD LINES TO REVERSE ROTATION

ASSEMBLY DIAGRAM CP6 CP8 CP909 CPI4 DIRECT DRIVE BLOWERS

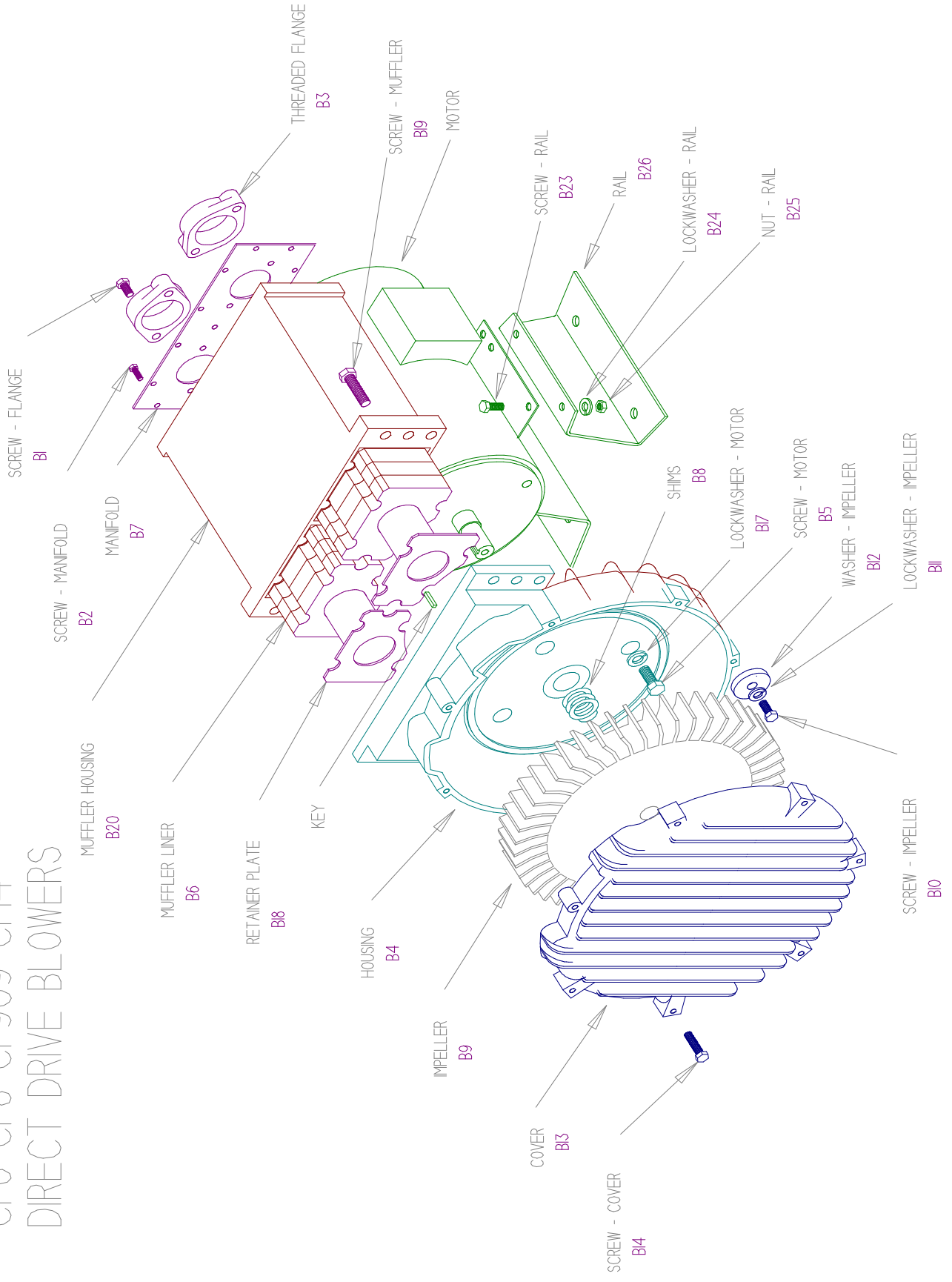

CP 6/858/909/14

Service and Parts Manual

Model:

Part No.:

Parts Breakdown

CP6

038252

038253

038978

038979

CP858

038748

038749

038980

038981

CP909

038631

038632

038982

038983

CP14

038757

038756

038984

038985

Item No.	Qty.	Description	See Next Page	See Next Page	See Next Page	See Next Page
M3	1	Key Motor Shaft	120065	155179	(6 pcs) 155185	(6 pcs) 155185
B1	4	Screw, Flange	Not Used	Not Used	Not Used	Not Used
B2		Screw, Manifold	551341	551342	529975	529975
B3	2	Flange	155350	Not Used	551731	551745
	2	Screen, Flange Guard/O-ring	Not Used	Not Used	155377	155377
B4	1	Housing	551314	551315	551316	551317
B5	4	Screw, Hsg /Motor	155338	155333	155332	155422
B6	7	Muffler Material (Grey)	Not Used	551736	(10 pcs) 551738	(12) 551740
	2	Muffler Material (White)	Not Used	551737	551739	551741
B7		Manifold Plate	Not Used	Not Used	Not Used	Not Used
B8	*	Shim .002"	272703	511547	511547	515991
	*	Shim .005"	272704	511548	511548	515992
	*	Shim .010"	272705	511549	511549	515993
	*	Shim .020"	272706	511550	511550	515994
	*	Shim .030"	Not Used	Not Used	Not Used	Not Used
B9	1	Impeller	529306	529307	529308	551358
B10	1	Bolt, Impeller	155327	155324	155323	155182
B11	1	Lockwasher, Impeller	251310	160524	160524	160524
B12	1	Washer, Impeller	Not Used	517487	Not Used	Not Used
B13	1	Cover	529160	517514	517518	517521
B14	8	Screw, Cover	155170	155185	155185	140044
B15	1	Eye Bolt	Not Used	140019	140019	140019
B16	1	Spacer, Impeller Bolt	529187	551360	517487	517487
		Shaft Sleeve	Not Used	Not Used	Not Used	Not Used
B17		Lockwasher, Housing	Not Used	Not Used	Not Used	Not Used
B18	1	Screen, Muffler Retaining, Right (**)	Not Used	551724	551726	551728
	1	Screen, Muffler Retaining, Left (**)	Not Used	551724	551726	551728

*As Needed **Viewed looking at inlet/outlet ports

B19	6	Bolt, Muffler Hsg/Hsg	Not Used	155179	155179	155181
B19A	4	Bolt, Muffler/Housing	Not Used	155467	155467	155467
B20	1	Muffler Housing	Not Used	550053	529935	550052
	1	Muffler Discrete	522948	Not Used	Not Used	Not Used
		Bolt, Motor/Muffler	Not Used	Not Used	Not Used	Not Used
		Lockwasher, Motor/Muffler	Not Used	Not Used	Not Used	Not Used
		Washer, Motor/Muffler	Not Used	Not Used	Not Used	Not Used
		Spacer, Motor/Muffler	Not Used	Not Used	Not Used	Not Used
B21		Heat Slinger	Not Used	Not Used	Not Used	Not Used
B22		Guard Heat Slinger	Not Used	Not Used	Not Used	Not Used
B23	4	Bolt, Rail	155327	121683	155192	155191
B24	4	Lockwasher Rail	251310	251310	251310	251310
B24A	4	Washer, Rail/Motor	Not Used	Not Used	See Next Page	155091
B25	4	Nut, Rail	121360	121360	121360	121360
B26	2	Rail Mounting	478338	595301	See Next Page	551687
	1	Lip Seal	516691	516693	516693	516694

Model	Part No.	Motor	Wiring Diagram	Specific Parts	Bearing, Rear (M1)	Bearing, Impeller End (M2)
CP6F89LR	038252	500297	K + L	M3 510212	510217	510218
CP6D89LR	038979	500291	C			
CP6FF89LR	038253	551350	C	M3 155319		
CP6FW89LR	038978	550476	K + L			
CP858BD72WLR	038748	515556	K + L	M3 511532		
CP858BB72WLR	038981	511571	C		516840	516844
CP858FH72WLR	038749	551351	C			
CP858FZ72WLR	038980	550477	K + L	M3 155176		
CP909BG72WLR	038631	511512		M3 511532		
				B24A 120477 (12 pcs)		
CP909GA72WLR	038982	550478	K + L	B26 515286 (2 pcs)	516842	516844
				M3 155176		
CP909FJ72WLR	038632	551352		B24A 551576 (8 pcs)		
				B26 551768 (2 pcs)		
CP909BE72WLR	038983	511572	C	M3 155176		
				B24A 120477 (8 pcs)		
				B26 595301 (2 pcs)	516840	516844
				M3 511532		
				B24A 120477 (8 pcs)		
				B26 595301 (2 pcs)		
CP14DX72MWLR	038756	516095	K + L	M3 155066		
CP14DW72MLR	038985	516096	C			
CP14FK72MWLR	038757	551353	C		516844	516846
CP14GC72MWLR	038984	550479	K + L	M3 155321		

* As Needed **Viewed looking at inlet/outlet ports